

TOOLS REQUIRED / OUTILS REQUIS

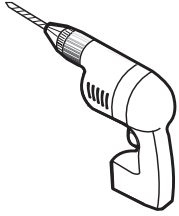

DRILL
PERCEUSE

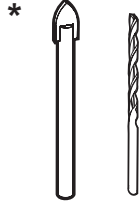

1/4" & 1/8" DRILL BITS
MÈCHE 1/4" & 1/8"



LOCKING PLIERS
PINCE SERRE



SCREWDRIVER
TOURNEVIS

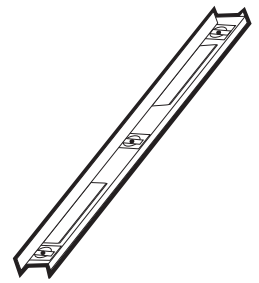

LEVEL
NIVEAU



PENCIL
CRAYON



SAFETY GLASSES
LUNETTES DE SÉCURITÉ

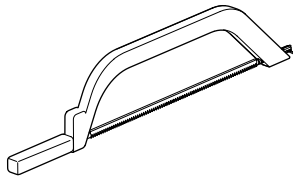

HACKSAW
SCIE À MÉTAUX



MALLET
MAILLET

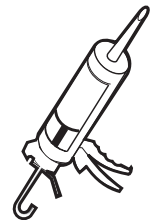

SILICONE
SCCELLANT

* Use a 1/4" drill bit for ceramic when drilling into ceramic tiles

* Utiliser une mèche de 1/4" destiné à céramique lors du perçage des tuiles en céramique.

DETECTING THE S.R.T SIDE ON THE GLASS / DÉTECTER LE CÔTÉ S.R.É SUR LE VERRE

The panels are treated differently on each side. Locate the Microtek and S.R.T label that is installed on the **MICROTEK** side (the **INTERIOR** side of the shower). Remove the sticker at the end of the installation.

Les panneaux ont un traitement différent sur chaque côté. Localiser l'étiquette Microtek et S.R.É qui est installée sur le côté du **MICROTEK** (la face **INTÉRIEURE** de la douche). Retirer l'étiquette à la fin de l'installation.

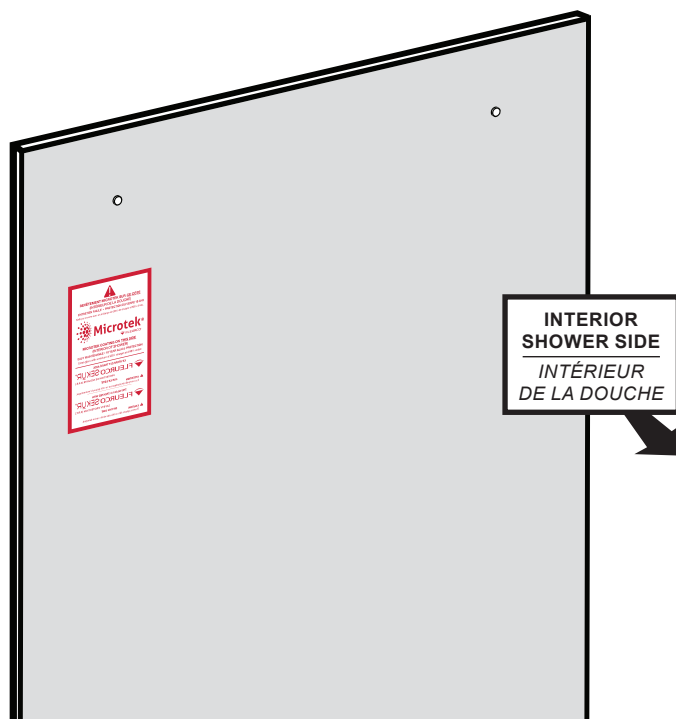

POSSIBLE CONFIGURATIONS / CONFIGURATIONS POSSIBLES

SHOWER / DOUCHE

TUB / BAIGNOIRE

*

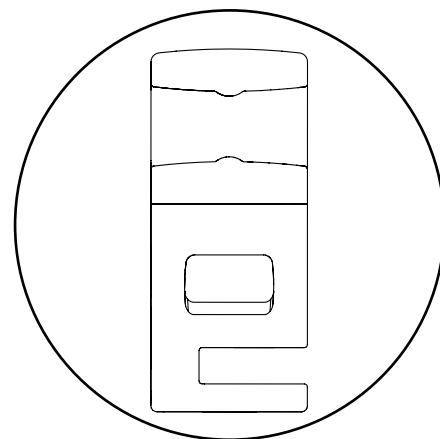
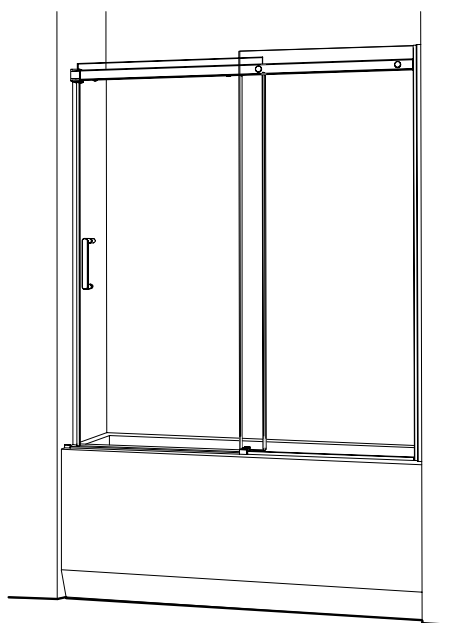
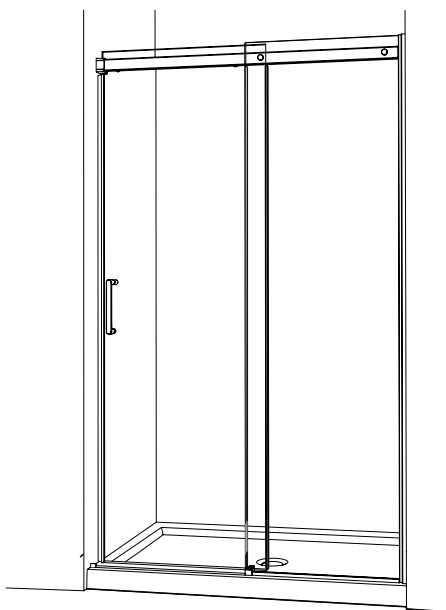

NAS-BTMGUIDE-XX-L

NAS__-__-40L

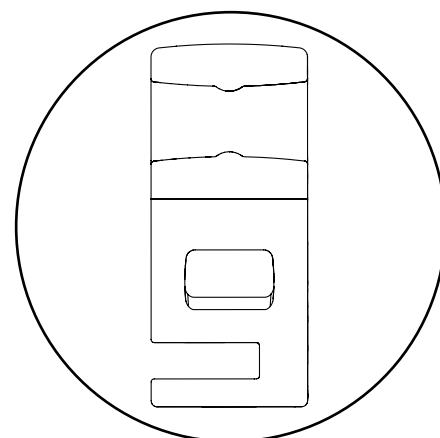
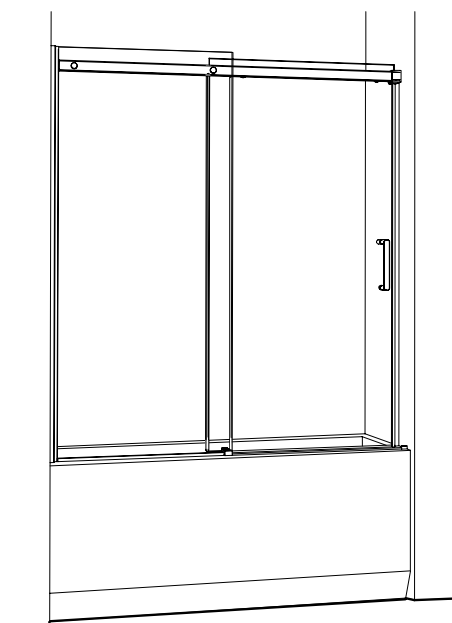
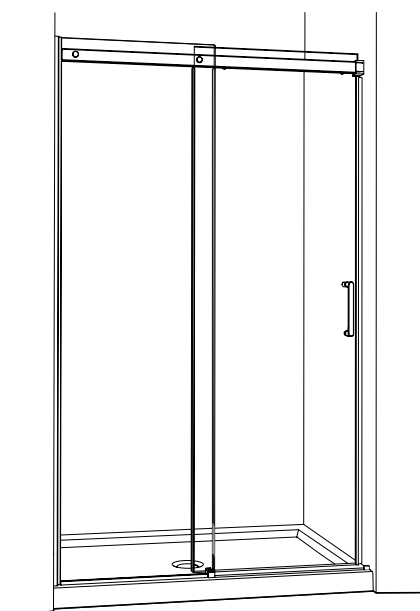

NAS-BTMGUIDE-XX-R

NAS__-__-40R

* THIS CONFIGURATION IS ILLUSTRATED IN THIS MANUAL. FOLLOW THE SAME STEPS FOR THE TUB BASE.

* CETTE CONFIGURATION EST ILLUSTRÉE DANS CE MANUEL. SUIVRE LES MÊMES ÉTAPES POUR LA BASE DE BAIGNOIRE.

PARTS LISTING / LISTE DES PIÈCES

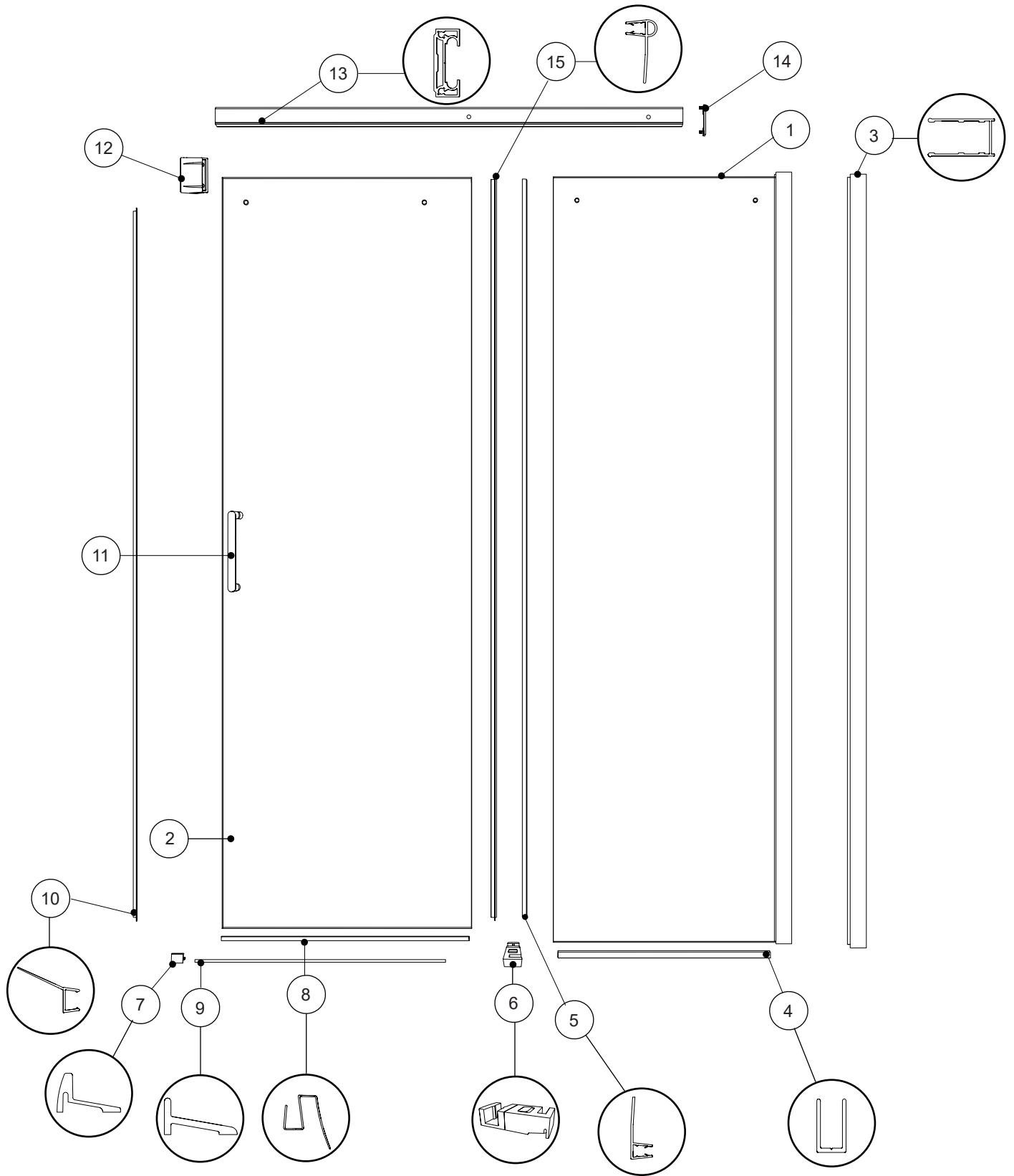

HARDWARE LISTING / LISTE DE QUINCAILLERIE

ITEM	FLEURCO CODE	PARTS LISTING / LISTE DES PIÈCES	QTY
1		FIXED PANEL / PANNEAU FIXE	1
2		DOOR PANEL / PANNEAU DE PORTE	1
3	PLAT-WJAMB-33-79 **15419-80	WALL JAMB / JAMBAGE	1
4	NA/PJ-UCHANNEL-42-XX	U-CHANNEL / PROFILÉ EN "U"	1
5	COEX-A310-72	SIDE GASKET / JOINT LATÉRAL	1
6	NAS-BTMGUIDE-XX-R NAS-BTMGUIDE-XX-L	BOTTOM GUIDE / GUIDE INFÉRIEUR	1
7	PENDCAP-XX	THRESHOLD ANCHOR / L'ANCRAGE DU SEUIL	1
8	COEX-N510-40	BOTTOM DOOR GASKET / JOINT INFÉRIEUR POUR LA PORTE	1
9	PLAT-THRESH-33-72 **15405	THRESHOLD / SEUIL	1
10	COEX-A201-75	SIDE DOOR GASKET - HANDLE SIDE / JOINT LATÉRAL DE LA PORTE - CÔTÉ POIGNÉE	1
11	NA-HANDLE-XX	DOOR HANDLE / POIGNÉE DE PORTE	1
12	NA-BRACKET-XX	WALL MOUNT BRACKET / SUPPORT MURAL	1
13	NA-BAR-48-XX NA-BAR-54-XX NA-BAR-60-XX NA-BAR-72-XX	RUNNING RAIL / BARRE DE ROULEMENT	1
14	NA-BCAP-XX	RAIL CAP / CAPUCHON DE RAIL	1
15	COEX-A200-72	SIDE DOOR GASKET / JOINT LATÉRAL DE LA PORTE	1
ITEM	CODE	HARDWARE LISTING / LISTE DE QUINCAILLERIE	QTY
16		WALL PLUG / CHEVILLE	6
17		CLEAR SETTING BLOCK (1/16") / BLOC À NIVEAU TRANSPARENT (1/16")	2
18		CLEAR SETTING BLOCK (1/8") / BLOC À NIVEAU TRANSPARENT (1/8")	2
19	NA-ROLLER-XX	WHEEL / ROULETTE	2
20		WHEEL CAP / CAPUCHON DE ROULETTE	2
21	NA-FASTENER-XX	FASTENER / FIXATION DE VERRE	2
22		KEY / CLÉ	1
23		PAN HEAD SCREW (ST4 x 35mm) / VIS À TÊTE PAN (ST4 x 35mm)	4
24		SCREW (ST5 x 35mm) / VIS (ST5 x 35mm)	2
25		PAN SELF-DRILLING SCREW (ST4.2 x 10mm) / VIS PAN AUTO-PERÇANTE (ST4.2 x 10mm)	3
26		SCREW CAP / CAPUCHON COUVRE-VIS	3
27		BACK SCREW CAP / L'ARRIÈRE DU CAPUCHON COUVRE-VIS	3
28		2MM HEX KEY / CLÉ HEXAGONALE 2MM	1
29		3MM HEX KEY / CLÉ HEXAGONALE 3MM	1

PARTS LISTING / LISTE DES PIÈCES

