

## TOOLS REQUIRED / OUTILS REQUIS

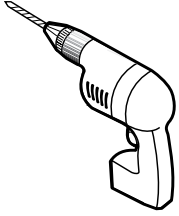

**DRILL**  
PERCEUSE



**1/4" & 1/8" DRILL BITS**  
MÈCHE 1/4" & 1/8"



**SCREWDRIVER**  
TOURNEVIS



**BLOCK**  
BLOC

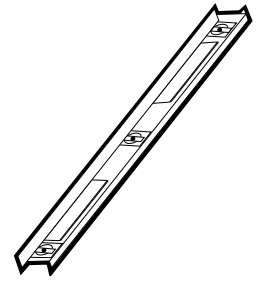

**LEVEL**  
NIVEAU



**PENCIL**  
CRAYON

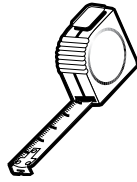

**TAPE MEASURE**  
RUBAN À MESURER

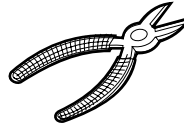

**CUTTING PLIERS**  
PINCE COUPANTE



**MALLET**  
MAILLET

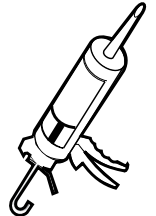

**SILICONE**  
SCELLANT

\* Use a 1/4" drill bit when drilling into ceramic tiles

\* Utiliser une mèche de 1/4" pour percer des tuiles en céramique.

## POSSIBLE PANEL CONFIGURATIONS / CONFIGURATIONS POSSIBLES DES PANNEAUX

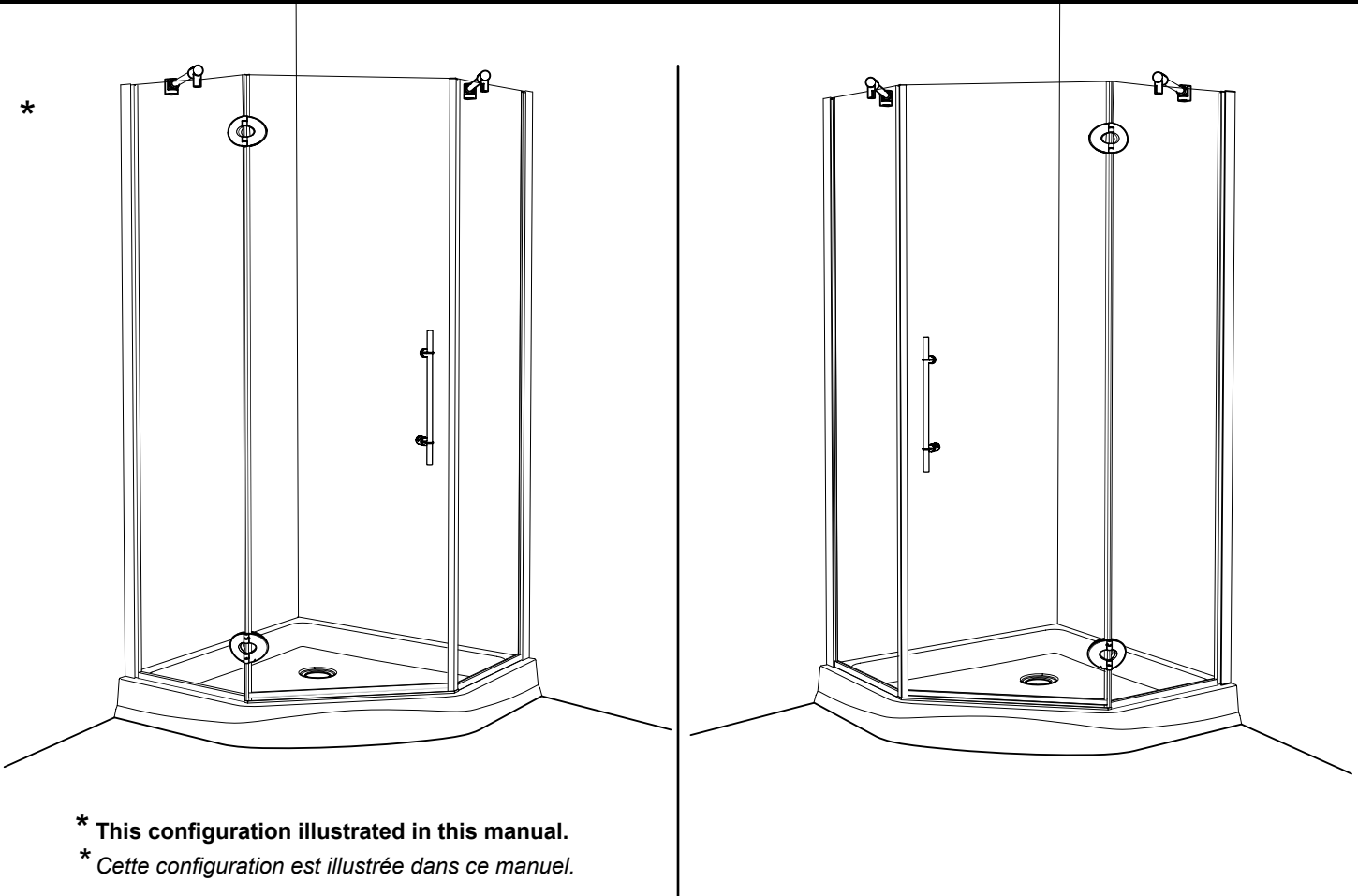

\* This configuration illustrated in this manual.

\* Cette configuration est illustrée dans ce manuel.

PARTS LISTING / LISTE DES PIÈCES

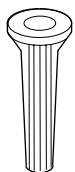
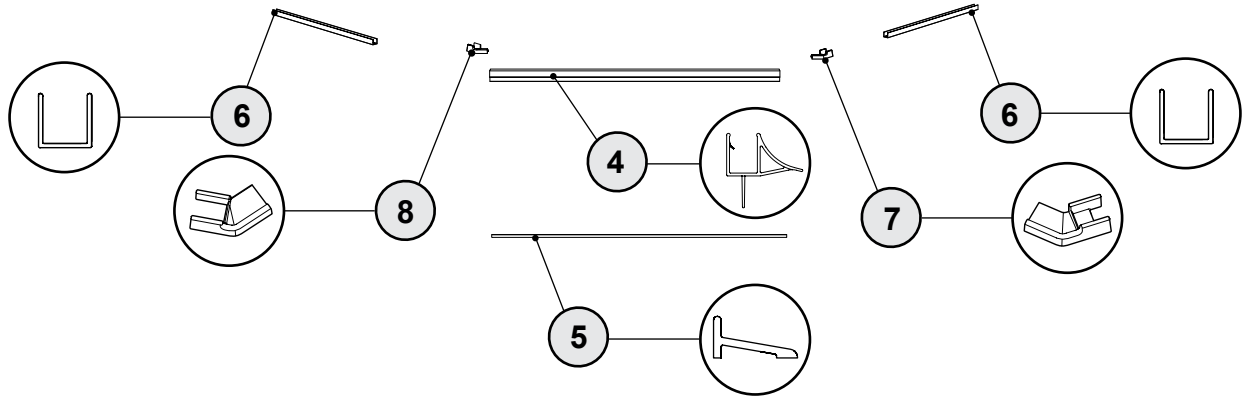
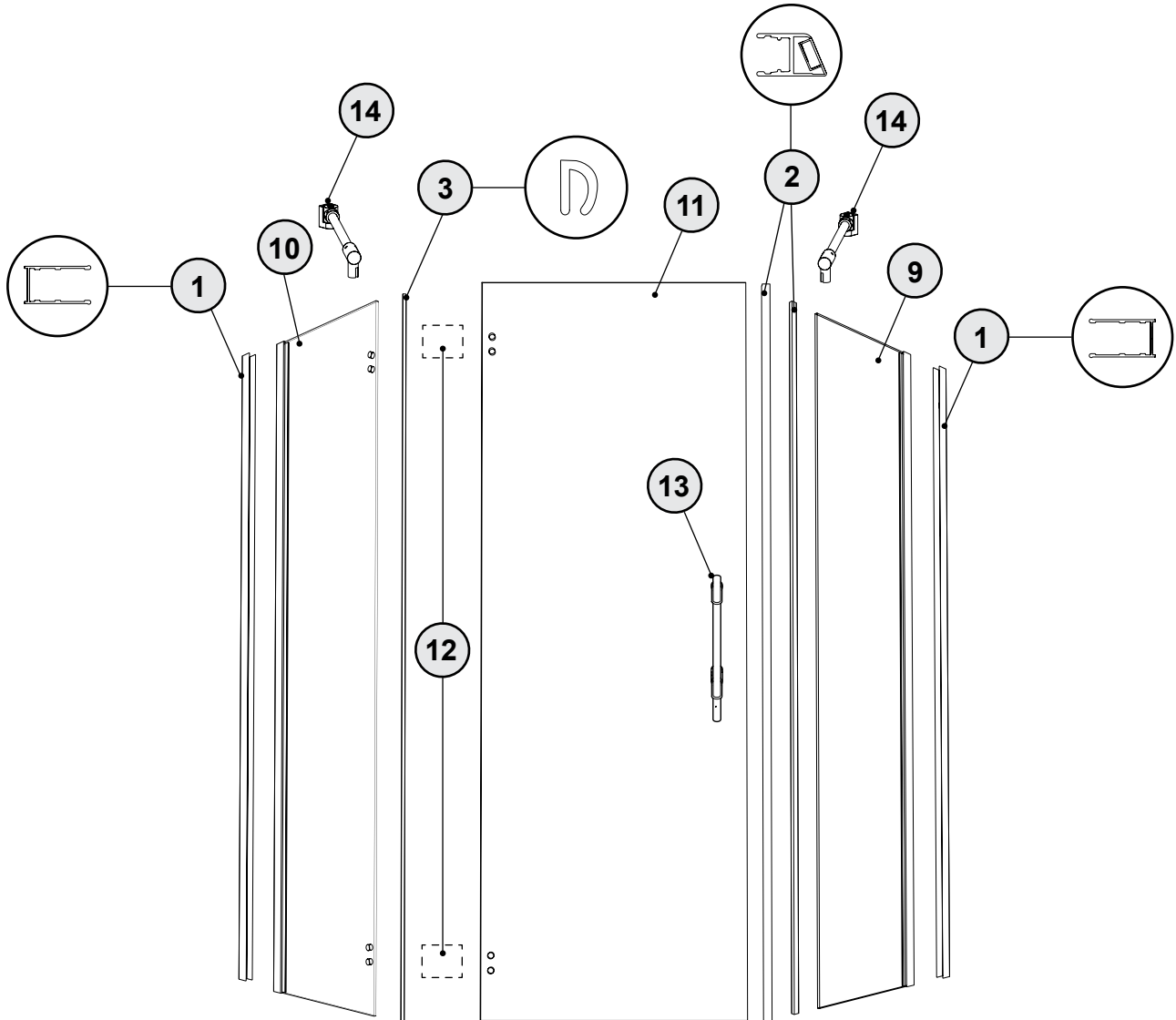

15



16



17



18



19

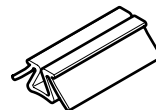

20

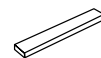

21



22

## PARTS LISTING / LISTE DES PIÈCES

ITEM	PARTS LISTING / LISTE DES PIÈCES	QTY
1	WALL JAMB / JAMBAGE	2
2	MAGNETIC GASKET / JOINT MAGNÉTIQUE	2
3	MID GASKET / JOINT LATÉRAL	1
4	BOTTOM DOOR GASKET / JOINT INFÉRIEUR DE LA PORTE	1
5	THRESHOLD / SEUIL	1
6	U-CHANNEL / PROFILÉ EN «U»	2
7	THRESHOLD ANCHOR / ANCRAGE DE SEUIL	1
8	THRESHOLD ANCHOR FOR HINGE SIDE / ANCRAGE DE SEUIL DU CÔTÉ CHARNIÈRES	1
9	FIXED PANEL / PANNEAU FIXE	1
10	HINGED FIXED PANEL / PANNEAU FIXE AVEC CHARNIÈRES	1
11	DOOR PANEL / PANNEAU DE PORTE	1
12	HINGE ( see chart below ) / CHARNIÈRE ( voir le tableau ci-dessous )	2
13	HANDLE / POIGNÉE	1
14	SUPPORT BAR / BARRE DE SUPPORT	2
15	WALL PLUGS / CHEVILLES	7
16	PAN SELF-DRILLING SCREW ( 1 ¼" ) / VIS PAN AUTO-PERÇANTE # 8 ( 1 ¼" )	6
17	PAN SELF-DRILLING SCREW # 8 ( ⅝" ) / VIS PAN AUTO-PERÇANTE # 8 ( ⅝" )	6
18	BACK SCREW CAP / L'ARRIÈRE DU CAPUCHON COUVRE-VIS	7
19	SCREW CAP / CAPUCHON COUVRE-VIS	7
20	2" SPACING BLOCK / BLOC ESPACEUR 2"	2
21	CLEAR SETTING BLOCK ( ⅙" ) / BLOC À NIVEAU TRANSPARENT ( ⅙" )	2
22	CLEAR SETTING BLOCK ( ⅛" ) / BLOC À NIVEAU TRANSPARENT ( ⅛" )	2

12	HINGE OPTIONS / SÉLECTION DES CHARNIÈRES	
Q	M	
