

## TOOLS REQUIRED / OUTILS REQUIS

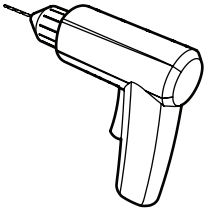

**DRILL**  
PERCEUSE

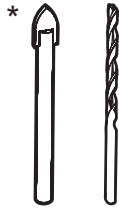

**1/4" & 1/8" DRILL BITS**  
MÈCHE DE 1/4" & 1/8"

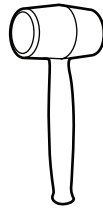

**MALLET**  
MAILLET



**SCREWDRIVER**  
TOURNEVIS

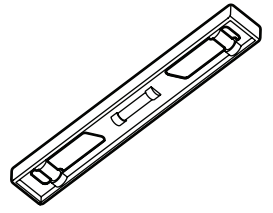

**LEVEL**  
NIVEAU

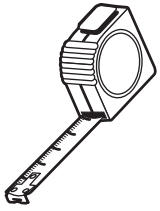

**TAPE MEASURE**  
RUBAN À MESURER



**PENCIL**  
CRAYON

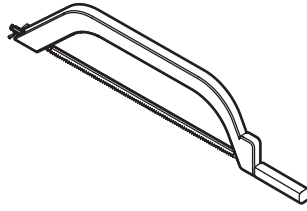

**HACKSAW**  
SCIE À MÉTAUX

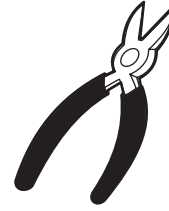

**CUTTING PLIERS**  
PINCE COUPANTE

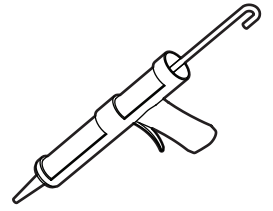

**SILICONE**  
SCCELLANT

- \* Use a 1/4" drill bit for ceramic when drilling into ceramic tiles
- \* Utiliser une mèche à céramique de 1/4" lors du perçage des tuiles.

## POSSIBLE CONFIGURATIONS / CONFIGURATIONS POSSIBLES

Cross-check the labels from the packaging with the code below to ensure the product is the correct one.

Vérifier que les étiquettes de l'emballage correspondent au code suivant pour s'assurer d'avoir le bon produit.

**SHOWER / DOUCHE**

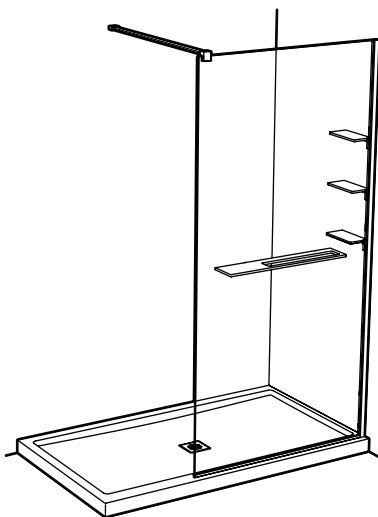

**VTR\_-33-40R\***

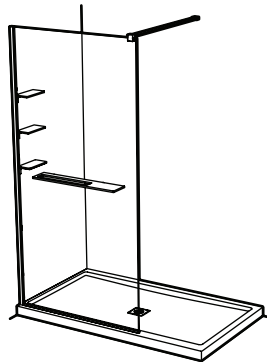

**VTR\_-33-40L**

**TUB / BAIGNOIRE**

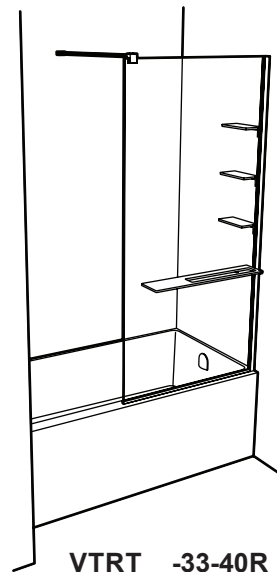

**VTRT\_-33-40R**

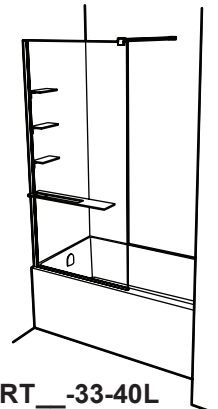

**VTRT\_-33-40L**

\* This configuration is illustrated in this manual / Cette configuration est illustrée dans ce manuel

PARTS AND HARDWARE LISTING / LISTE DES PIÈCES ET QUINCAILLERIE

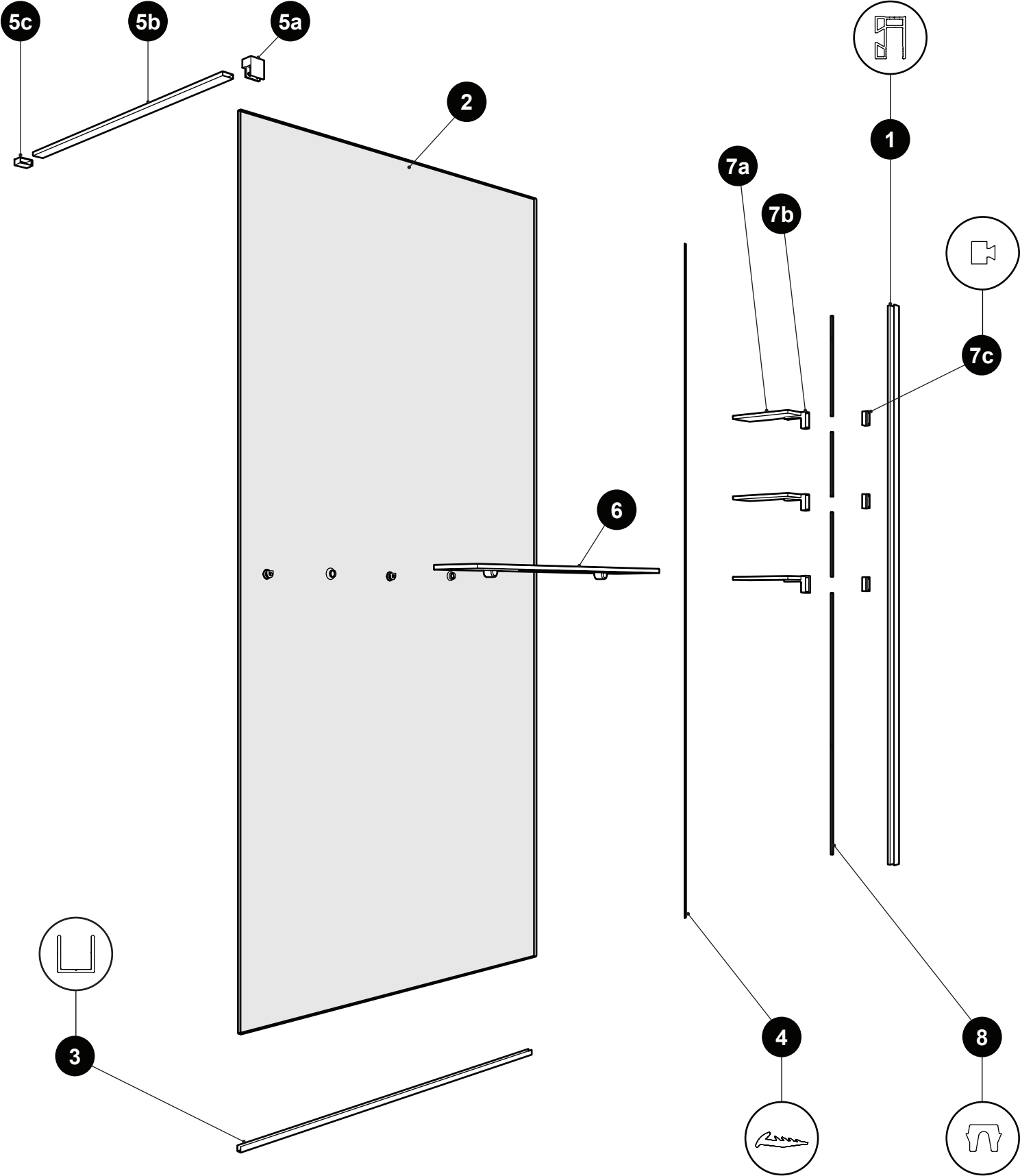

**PARTS AND HARDWARE LISTING / LISTE DES PIÈCES ET QUINCAILLERIE**



9



10



11

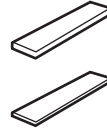

12



13

ITEM	FLEURCO CODE	PARTS AND HARDWARE / PIÈCES ET QUINCAILLERIE	QTY
1	VTR-WJAMB-33-79	WALL JAMB + ACCESSORIES GROOVE / JAMBAGE AVEC FENTE POUR ACCESSOIRES	2
2		GLASS PANEL / PANNEAU DE VERRE	1
3	PLAT-UCHANNEL-33-72	U-CHANNEL / PROFILÉ EN «U»	1
4	VINYL-NH-S-86	VINYL GASKET / JOINT EN VINYLE	1
5a	VTR-BRACKET-S-33	GLASS MOUNT BRACKET / SUPPORT DE VERRE	1
5b	LAVBAR-33-70	SUPPORT BAR / BARRE DE SUPPORT	1
5c	PJ-BRACKET-33 / LAV-BRACKET-33	WALL MOUNT BRACKET / SUPPORT MURAL	1
		WALL MOUNT PLATE BRACKET / PLAQUE DE SUPPORT MURAL	1
6	VTR-TOWELBAR-33-R	TRAY - TOWEL BAR / PLATEAU - PORTE SERVIETTE	1
	VTR-TOWELBAR-33-L		
7a	VTR-SHELF-33	SHELF / TABLETTE	3
7b	VTR-SHBRACKET-33	SHELF BRACKET / SUPPORT DE TABLETTE	3
7c		SHELF FASTENER / FIXATION DU SUPPORT DE TABLETTE	3
8	VINYL-VTR-120 / VINYL-VTR-120-33	WALL JAMB GROOVE GASKET / JOINT POUR FENTE DU JAMBA GE	1
9		WALL PLUG / CHEVILLE	4
10		PAN HEAD SCREW / VIS À TÊTE CYLINDRIQUE	3
11		FLAT HEAD SCREW / VIS À TÊTE PLATE	1
12		CLEAR SETTING BLOCKS (1/16" AND 1/8") / BLOCS NIVEAU TRANSPARENT (1/16" ET 1/8")	4
13		2.5MM, 3MM AND 4MM HEX KEYS / CLÉS HEXAGONALES DE 2.5MM, 3MM ET 4MM	3